



CLASSIC /

DESCRIPCIÓN /

- Archivo horizontal clásico. Resistente, amplio y funcional. En chapa metálica pintado con pintura epoxy.
- Mueble estándar de 10 cajones. Compuesto por dos módulos de 5 cajones, tapa y zócalo.
- Frontal de cajones con tirador de plástico negro y dos portaetiquetas.
- Guías equipadas con rodamientos a bolas. Deslizamiento suave. 70% de extracción.
- Freno mecánico al final de las guías.
- Cerradura con llave en cada módulo de cajones.
- Carga máxima: 25kg uniformemente repartidos en cada cajón.
- Disponible con 2, 3, 4, 5 cajones y 3 combinaciones de diferentes cajones.
- Apilable hasta 5 módulos.
- Diferentes opciones y accesorios.

DESCRIPTION /

- Classic horizontal archive. Solid, spacious and functional. In epoxy-painted metal sheet.
- Standard unit with 10 drawers. Composed of two modules of 5 drawers, top and base.
- Front panel of drawers with black plastic handle and two label holders.
- Guides fitted with ball bearings. Smooth operation. 70% extraction.
- Mechanical brake at guide end stop.
- Lock on each drawer module.
- Maximum load: 25 kg uniformly distributed in each drawer.
- Available with 2, 3, 4, 5 drawers and 3 combinations of different drawers.
- Stackable up to 5 modules.
- Various options and accessories available.

DESCRIPTION /

- Classeur horizontal classique. Résistant, spacieux et fonctionnel. En tôle métallique et peinture époxy.
- Meuble standard à 10 tiroirs. Constitué de deux modules à 5 tiroirs, dessus et socle.
- Partie avant des tiroirs avec poignée en plastique noir et deux porte-étiquettes.
- Coulisses équipées de roulements à billes. Coulissement doux. Extraction à 70%.
- Amortisseur à la fin des coulisses.
- Serrure de sécurité dans chaque module à tiroirs.
- Charge maximale : 25kg répartis uniformément dans chaque tiroir.
- Disponible avec 2, 3, 4, 5 tiroirs et 3 combinaisons de différents tiroirs.
- Jusqu'à 5 modules empilables.
- Différentes options et divers accessoires disponibles.

COLOR / COLOUR / COLORIS /



RAL 9002 - Texture
Blanco Grisáceo / Grey White / Blanc Gris

/ Posibilidad de otros colores bajo pedido
/ Possibility of other colors upon request
/ Possibilité d'autres couleurs sur demande

MUEBLE ESTÁNDAR / STANDARD CABINET / MEUBLE STANDARD /

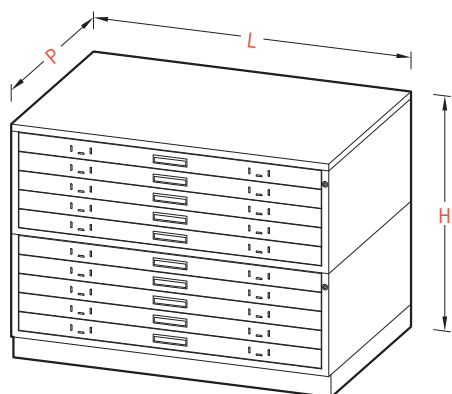

REF.	DESCRIPCIÓN / DESCRIPTION / DESCRIPTION	FORMATO / FORMAT / FORMAT	MEDIDAS / DIMENSIONS / MESURES		
			L	P	H
CLA0.10	Archivo Horizontal de 10 Cajones Filing Cabinet with 10 Drawers <i>Meubles à plans avec 10 Tiroirs</i>	DIN A0 Plus	1410	970	1034
CLA1.10	Archivo Horizontal de 10 Cajones Filing Cabinet with 10 Drawers <i>Meubles à plans avec 10 Tiroirs</i>	DIN A1 Plus	1130	810	1034

MÓDULOS DE AMPLIACIÓN / EXTRA DRAWER UNITS / MODULES D'ÉLARGISSEMENT /

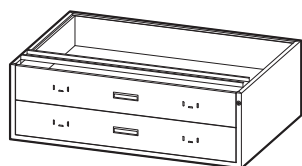

CLMA0.2 / CLMA1.2

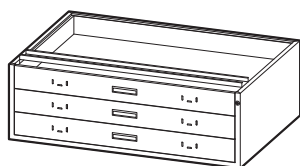

CLMA0.3 / CLMA1.3

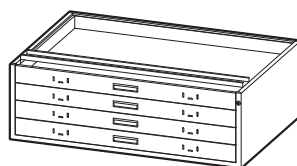

CLMA0.4 / CLMA1.4

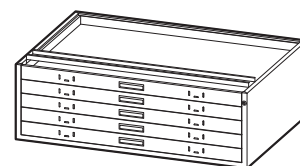

CLMA0.5 / CLMA1.5
/ Módulo de ampliación estándar
/ Standard extra drawer unit
/ Module d'élargissement standard

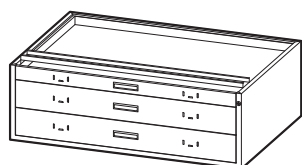

CLMA0.1.2 / CLMA1.1.2

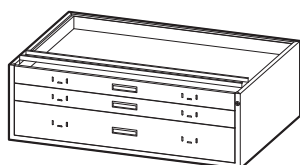

CLMA0.2.1 / CLMA1.2.1

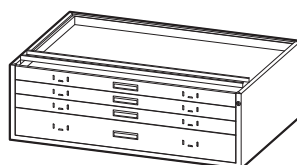

CLMA0.3.1 / CLMA1.3.1

REF.	NÚMERO DE CAJONES / NUMBER OF DRAWERS / NOMBRE DE TIROIRS	REFERENCIA DE LOS CAJONES / DRAWER REF. / RÉF. DES TIROIRS	FORMATO / FORMAT / FORMAT	MEDIDAS / DIMENSIONS / MESURES		
				L	P	H
CLMA0.2	2 Cajones / 2 Drawers / 2 Tiroirs	2 x CLFRA0.210	DIN A0 Plus	1410	970	453
CLMA0.3	3 Cajones / 3 Drawers / 3 Tiroirs	3 x CLFRA0.140	DIN A0 Plus	1410	970	453
CLMA0.4	4 Cajones / 4 Drawers / 4 Tiroirs	4 x CLFRA0.105	DIN A0 Plus	1410	970	453
CLMA0.5	5 Cajones / 3 Drawers / 5 Tiroirs	5 x CLFRA0.84	DIN A0 Plus	1410	970	453
CLMA0.1.2	3 Cajones / 3 Drawers / 3 Tiroirs	1 x CLFRA0.84 + 2 x CLFRA0.168	DIN A0 Plus	1410	970	453
CLMA0.2.1	3 Cajones / 3 Drawers / 3 Tiroirs	2 x CLFRA0.105 + 1 x CLFRA0.210	DIN A0 Plus	1410	970	453
CLMA0.3.1	4 Cajones / 4 Drawers / 4 Tiroirs	3 x CLFRA0.84 + 1 x CLFRA0.168	DIN A0 Plus	1410	970	453
CLMA1.2	2 Cajones / 2 Drawers / 2 Tiroirs	2 x CLFRA1.210	DIN A1 Plus	1130	810	453
CLMA1.3	3 Cajones / 3 Drawers / 3 Tiroirs	3 x CLFRA1.140	DIN A1 Plus	1130	810	453
CLMA1.4	4 Cajones / 4 Drawers / 4 Tiroirs	4 x CLFRA1.105	DIN A1 Plus	1130	810	453
CLMA1.5	5 Cajones / 3 Drawers / 5 Tiroirs	5 x CLFRA1.84	DIN A1 Plus	1130	810	453
CLMA1.1.2	3 Cajones / 3 Drawers / 3 Tiroirs	1 x CLFRA1.84 + 2 x CLFRA1.168	DIN A1 Plus	1130	810	453
CLMA1.2.1	3 Cajones / 3 Drawers / 3 Tiroirs	2 x CLFRA1.105 + 1 x CLFRA1.210	DIN A1 Plus	1130	810	453
CLMA1.3.1	4 Cajones / 4 Drawers / 4 Tiroirs	3 x CLFRA1.84 + 1 x CLFRA1.168	DIN A1 Plus	1130	810	453

COMPLEMENTOS / COMPLEMENTS / COMPLÉMENTS /



REF.	DESCRIPCIÓN / DESCRIPTION / DESCRIPTION	FORMATO / FORMAT / FORMAT	MEDIDAS / DIMENSIONS / MESURES		
			L	P	H
SMA0	Tapa en chapa de acero / Steel sheet top / Dessus en tôle d'acier	DIN A0 Plus	1410	966	28 mm
ZMA0	Zócalo en chapa de acero / Steel sheet base / Socle en tôle d'acier	DIN A0 Plus	1410	940	100 mm
STMA0	Base con patas / Base with legs / Base avec pieds	DIN A0 Plus	1410	966	420 mm
SMA1	Tapa en chapa de acero / Steel sheet top / Dessus en tôle d'acier	DIN A1 Plus	1130	810	28 mm
ZMA1	Zócalo en chapa de acero / Steel sheet base / Socle en tôle d'acier	DIN A1 Plus	1130	784	100 mm
STMA1	Base con patas / Base with legs / Base avec pieds	DIN A1 Plus	1130	810	420 mm
WHMA01	Base con ruedas / Base with wheels / Base avec roulettes	DIN A0/A1 Plus			110 mm

CAJONES / DRAWERS / TIROIRS /

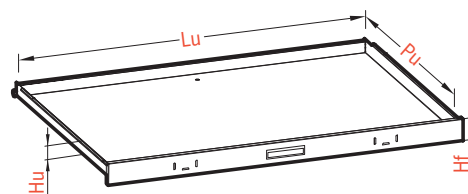

REF.	ALTURA FRONTAL / FRONT HEIGHT / HAUTEUR FAÇADE	CARGA MÁX. / MAX. LOAD / CHARGE MAX.	MEDIDA / SIZE / TAILLE	MEDIDAS ÚTILES / USEFULL DIM. / MES. UTILES		
	Hf			Cm	Lu	Pu
CLFRA0.84	84	25 Kg	DIN A0 Plus	1310	920	55 mm
CLFRA0.105	105	25 Kg	DIN A0 Plus	1310	920	75 mm
CLFRA0.140	140	25 Kg	DIN A0 Plus	1310	920	110 mm
CLFRA0.168	168	25 Kg	DIN A0 Plus	1310	920	135 mm
CLFRA0.210	210	25 Kg	DIN A0 Plus	1310	920	180 mm
CLFRA1.84	84	25 Kg	DIN A1 Plus	1030	760	55 mm
CLFRA1.105	105	25 Kg	DIN A1 Plus	1030	760	75 mm
CLFRA1.140	140	25 Kg	DIN A1 Plus	1030	760	110 mm
CLFRA1.168	168	25 Kg	DIN A1 Plus	1030	760	135 mm
CLFRA1.210	210	25 Kg	DIN A1 Plus	1030	760	180 mm

OPCIONES EXTRA / EXTRA OPTIONS / OPTIONS SUPPLÉMENTAIRES /



Cajones de 40Kg (uniformemente repartidos) / 40Kg drawers (evenly distributed) /
Tiroirs de 40Kg (uniformément distribué)



Sistema anti-vuelco / Anti-tilt system / Système anti-basculement



Guías telescópicas 45Kg / 45Kg telescopic guides / Guides télescopiques 45Kg

REF.	CAJONES DE 40 KG / 40 KG DRAWERS / TIROIRS DE 40 KG	SISTEMA ANTIVUELCO / ANTI-TILT SYSTEM / SYSTÈME ANTI-BASCULEMENT	GUIA TELESCÒPICA / TELESCOPIC GUIDE / GUIDE TÉLESCOPIQUE
CLMA0.2	CLXA0.2.HL	CLXA0.2.AT	CLXA0.2.TG
CLMA0.3	CLXA0.3.HL	CLXA0.3.AT	CLXA0.3.TG
CLMA0.4	CLXA0.4.HL	CLXA0.4.AT	CLXA0.4.TG
CLMA0.5	CLXA0.5.HL	CLXA0.5.AT	CLXA0.5.TG
CLMA0.1.2	CLXA0.1.2.HL	CLXA0.1.2.AT	CLXA0.1.2.TG
CLMA0.2.1	CLXA0.2.1.HL	CLXA0.2.1.AT	CLXA0.2.1.TG
CLMA0.3.1	CLXA0.3.1.HL	CLXA0.3.1.AT	CLXA0.3.1.TG
CLMA1.2	CLXA1.2.HL	CLXA1.2.AT	CLXA1.2.TG
CLMA1.3	CLXA1.3.HL	CLXA1.3.AT	CLXA1.3.TG
CLMA1.4	CLXA1.4.HL	CLXA1.4.AT	CLXA1.4.TG
CLMA1.5	CLXA1.5.HL	CLXA1.5.AT	CLXA1.5.TG
CLMA1.1.2	CLXA1.1.2.HL	CLXA1.1.2.AT	CLXA1.1.2.TG
CLMA1.2.1	CLXA1.2.1.HL	CLXA1.2.1.AT	CLXA1.2.1.TG
CLMA1.3.1	CLXA1.3.1.HL	CLXA1.3.1.AT	CLXA1.3.1.TG

ACCESORIOS / ACCESSORIES / ACCESSOIRES /



AH40 Separadores (x12 u.) / Separators (x12u.) / Séparateurs (x12 u.)



PWA0/ PWA1 Pisapapeles / Paper-weight / Presse-papiers

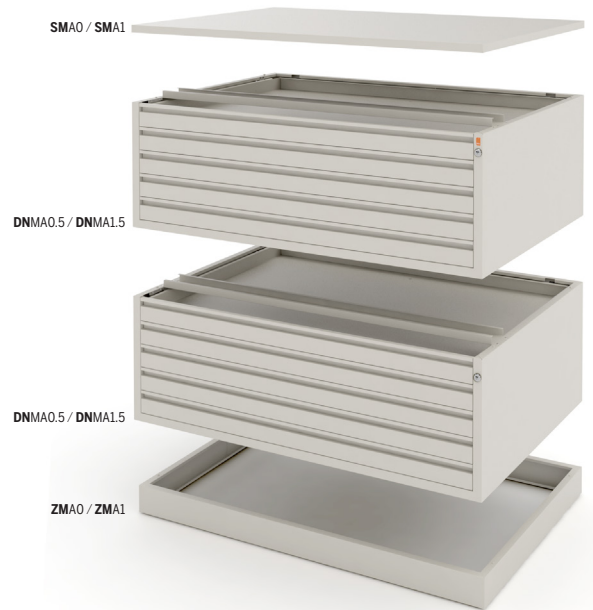

DINAMIC /

DESCRIPCIÓN /

- Archivo horizontal versátil, robusto, amplio y funcional. En chapa metálica pintado con pintura epoxy.
- Mueble estándar de 10 cajones. Compuesto por dos módulos de 5 cajones, tapa y zócalo.
- Frontal de cajones con tirador en toda la longitud del cajón.
- Guías equipadas con rodamientos a bolas. Deslizamiento suave. 70% de extracción.
- Freno mecánico al final de las guías
- Cerradura con llave en cada módulo de cajones.
- Carga máxima: 25kg uniformemente repartidos en cada cajón.
- Disponible con 2, 3, 4, 5 cajones y 3 combinaciones de diferentes cajones.
- Apilable hasta 5 módulos.
- Disponibles diferentes opciones y accesorios.

DESCRIPTION /

- Horizontal archive, versatile, robust, spacious and functional. In epoxy-painted metal sheet.
- Standard unit with 10 drawers. Composed of two modules of 5 drawers, top and base.
- Front panel of drawers with full-width handle.
- Guides fitted with ball bearings. Smooth operation. 70% extraction.
- Mechanical brake at guide end stop.
- Lock on each drawer module.
- Maximum load: 25 kg uniformly distributed in each drawer.
- Available with 2, 3, 4, 5 drawers and 3 combinations of different drawers.
- Stackable up to 5 modules.
- Various options and accessories available.

DESCRIPTION /

- Classeur horizontal polyvalent, robuste, spacieux et fonctionnel. En tôle métallique et peinture époxy.
- Meuble standard à 10 tiroirs. Constitué de deux modules à 5 tiroirs, dessus et socle.
- Partie avant des tiroirs avec poignée sur toute la longueur du tiroir.
- Coulisses équipées de roulements à billes. Coulissement doux. Extraction à 70%.
- Amortisseur à la fin des coulisses.
- Serrure de sécurité dans chaque module à tiroirs.
- Charge maximale : 25kg répartis uniformément dans chaque tiroir.
- Disponible avec 2, 3, 4, 5 tiroirs et 3 combinaisons de différents tiroirs.
- Jusqu'à 5 modules empilables.
- Différentes options et divers accessoires disponibles.

COLOR / COLOUR / COLORIS /

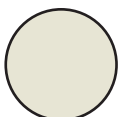

RAL 9002 - Texture
Blanco Grisáceo / Grey White / Blanc Gris

/ Posibilidad de otros colores bajo pedido
/ Possibility of other colors upon request
/ Possibilité d'autres couleurs sur demande

MUEBLE ESTÁNDAR / STANDARD CABINET / MEUBLE STANDARD /

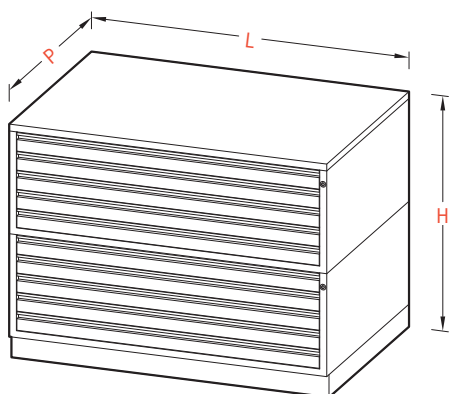

REF.	DESCRIPCIÓN / DESCRIPTION / DESCRIPTION	FORMATO / FORMAT / FORMAT	MEDIDAS / DIMENSIONS / MESURES		
			L	P	H
DNA0.10	Archivo Horizontal de 10 Cajones Filing Cabinet with 10 Drawers <i>Meubles à plans avec 10 Tiroirs</i>	DIN A0 Plus	1410	970	1034
DNA1.10	Archivo Horizontal de 10 Cajones Filing Cabinet with 10 Drawers <i>Meubles à plans avec 10 Tiroirs</i>	DIN A1 Plus	1130	810	1034

MÓDULOS DE AMPLIACIÓN / EXTRA DRAWER UNITS / MODULES D'ÉLARGISSEMENT /

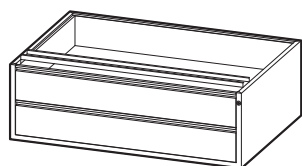

DNMA0.2 / DNMA1.2

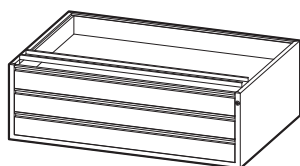

DNMA0.3 / DNMA1.3

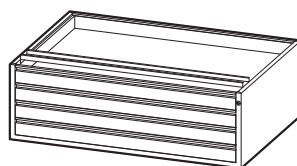

DNMA0.4 / DNMA1.4

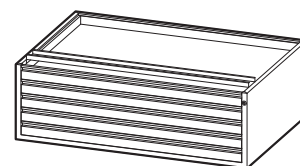

DNMA0.5 / DNMA1.5
/ Módulo de ampliación estándar
/ Standard extra drawer unit
/ Module d'élargissement standard

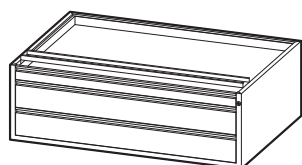

DNMA0.1.2 / DNMA1.1.2

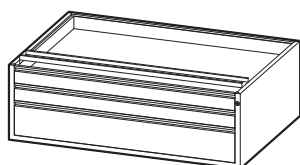

DNMA0.2.1 / DNMA1.2.1

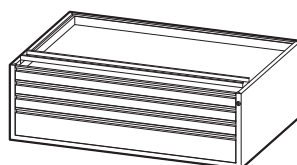

DNMA0.3.1 / DNMA1.3.1

REF.	NÚMERO DE CAJONES / NUMBER OF DRAWERS / NOMBRE DE TIROIRS	REFERENCIA DE LOS CAJONES / DRAWER REF. / RÉF. DES TIROIRS	FORMATO / FORMAT / FORMAT	MEDIDAS / DIMENSIONS / MESURES		
				L	P	H
DNMA0.2	2 Cajones / 2 Drawers / 2 Tiroirs	2 x DNFRA0.210	DIN A0 Plus	1410	970	453
DNMA0.3	3 Cajones / 3 Drawers / 3 Tiroirs	3 x DNFRA0.140	DIN A0 Plus	1410	970	453
DNMA0.4	4 Cajones / 4 Drawers / 4 Tiroirs	4 x DNFRA0.105	DIN A0 Plus	1410	970	453
DNMA0.5	5 Cajones / 3 Drawers / 5 Tiroirs	5 x DNFRA0.84	DIN A0 Plus	1410	970	453
DNMA0.1.2	3 Cajones / 3 Drawers / 3 Tiroirs	1 x DNFRA0.84 + 2 x DNFRA0.168	DIN A0 Plus	1410	970	453
DNMA0.2.1	3 Cajones / 3 Drawers / 3 Tiroirs	2 x DNFRA0.105 + 1 x DNFRA0.210	DIN A0 Plus	1410	970	453
DNMA0.3.1	4 Cajones / 4 Drawers / 4 Tiroirs	3 x DNFRA0.84 + 1 x DNFRA0.168	DIN A0 Plus	1410	970	453
DNMA1.2	2 Cajones / 2 Drawers / 2 Tiroirs	2 x DNFRA1.210	DIN A1 Plus	1130	810	453
DNMA1.3	3 Cajones / 3 Drawers / 3 Tiroirs	3 x DNFRA1.140	DIN A1 Plus	1130	810	453
DNMA1.4	4 Cajones / 4 Drawers / 4 Tiroirs	4 x DNFRA1.105	DIN A1 Plus	1130	810	453
DNMA1.5	5 Cajones / 3 Drawers / 5 Tiroirs	5 x DNFRA1.84	DIN A1 Plus	1130	810	453
DNMA1.1.2	3 Cajones / 3 Drawers / 3 Tiroirs	1 x DNFRA1.84 + 2 x DNFRA1.168	DIN A1 Plus	1130	810	453
DNMA1.2.1	3 Cajones / 3 Drawers / 3 Tiroirs	2 x DNFRA1.105 + 1 x DNFRA1.210	DIN A1 Plus	1130	810	453
DNMA1.3.1	4 Cajones / 4 Drawers / 4 Tiroirs	3 x DNFRA1.84 + 1 x DNFRA1.168	DIN A1 Plus	1130	810	453

COMPLEMENTOS / COMPLEMENTS / COMPLÉMENTS /



REF.	DESCRIPCIÓN / DESCRIPTION / DESCRIPTION	FORMATO / FORMAT / FORMAT	MEDIDAS / DIMENSIONS / MESURES		
			L	P	H
SMA0	Tapa en chapa de acero / Steel sheet top / Dessus en tôle d'acier	DIN A0 Plus	1410	966	28 mm
ZMA0	Zócalo en chapa de acero / Steel sheet base / Socle en tôle d'acier	DIN A0 Plus	1410	940	100 mm
STMA0	Base con patas / Base with legs / Base avec pieds	DIN A0 Plus	1410	966	420 mm
SMA1	Tapa en chapa de acero / Steel sheet top / Dessus en tôle d'acier	DIN A1 Plus	1130	810	28 mm
ZMA1	Zócalo en chapa de acero / Steel sheet base / Socle en tôle d'acier	DIN A1 Plus	1130	784	100 mm
STMA1	Base con patas / Base with legs / Base avec pieds	DIN A1 Plus	1130	810	420 mm
WHMA01	Base con ruedas / Base with wheels / Base avec roulettes	DIN A0/A1 Plus			110 mm

CAJONES / DRAWERS / TIROIRS /

Los cajones tipo **TISSA** DINAMIC se pueden combinar con los del modelo **TISSA** COMPACT.

The **TISSA** DINAMIC type drawers can be combined with those of the **TISSA** COMPACT model.

Les tiroirs type **TISSA** DINAMIC peuvent se combiner avec ceux du modèle **TISSA** COMPACT.

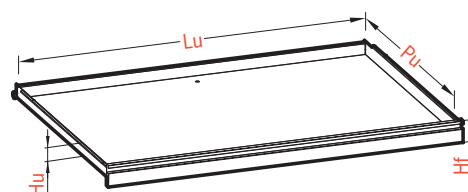

REF.	ALTURA FRONTAL / FRONT HEIGHT / HAUTEUR FAÇADE	CARGA MÁX. / MAX. LOAD / CHARGE MAX.	MEDIDA / SIZE / TAILLE	MEDIDAS ÚTILES / USEFULL DIM. / MES. UTILES		
	Hf	Cm		Lu	Pu	Hu
DNFRA0.84	84	25 Kg	DIN A0 Plus	1310	920	55 mm
DNFRA0.105	105	25 Kg	DIN A0 Plus	1310	920	75 mm
DNFRA0.140	140	25 Kg	DIN A0 Plus	1310	920	110 mm
DNFRA0.168	168	25 Kg	DIN A0 Plus	1310	920	135 mm
DNFRA0.210	210	25 Kg	DIN A0 Plus	1310	920	180 mm
DNFRA1.84	84	25 Kg	DIN A1 Plus	1030	760	55 mm
DNFRA1.105	105	25 Kg	DIN A1 Plus	1030	760	75 mm
DNFRA1.140	140	25 Kg	DIN A1 Plus	1030	760	110 mm
DNFRA1.168	168	25 Kg	DIN A1 Plus	1030	760	135 mm
DNFRA1.210	210	25 Kg	DIN A1 Plus	1030	760	180 mm

OPCIONES EXTRA / EXTRA OPTIONS / OPTIONS SUPPLÉMENTAIRES /



Cajones de 40Kg (uniformemente repartidos) / 40Kg drawers (evenly distributed) / *Tiroirs de 40Kg (uniformément distribué)*



Sistema anti-vuelco / Anti-tilt system / *Système anti-basculement*



Guías telescópicas 45Kg / 45Kg telescopic guides / *Guides télescopiques 45Kg*



Frontal abatible / Folding front / *Façada rabattable*

REF.	CAJONES DE 40 KG / 40 KG DRAWERS / TIROIRS DE 40 KG	SISTEMA ANTIVUELCO / ANTI-TILT SYSTEM / SYSTÈME ANTI-BASCULEMENT	GUIA TELESCÒPICA / TELESCOPIC GUIDE / GUIDE TÉLESCOPIQUE	FRONTAL ABATIBLE / FOLDING FRONT / FAÇADA RABATTABLE
DNMA0.2	DNXA0.2.HL	DNXA0.2.AT	DNXA0.2.TG	DNXA0.2.FF
DNMA0.3	DNXA0.3.HL	DNXA0.3.AT	DNXA0.3.TG	DNXA0.3.FF
DNMA0.4	DNXA0.4.HL	DNXA0.4.AT	DNXA0.4.TG	DNXA0.4.FF
DNMA0.5	DNXA0.5.HL	DNXA0.5.AT	DNXA0.5.TG	DNXA0.5.FF
DNMA0.1.2	DNXA0.1.2.HL	DNXA0.1.2.AT	DNXA0.1.2.TG	DNXA0.1.2.FF
DNMA0.2.1	DNXA0.2.1.HL	DNXA0.2.1.AT	DNXA0.2.1.TG	DNXA0.2.1.FF
DNMA0.3.1	DNXA0.3.1.HL	DNXA0.3.1.AT	DNXA0.3.1.TG	DNXA0.3.1.FF
DNMA1.2	DNXA1.2.HL	DNXA1.2.AT	DNXA1.2.TG	DNXA1.2.FF
DNMA1.3	DNXA1.3.HL	DNXA1.3.AT	DNXA1.3.TG	DNXA1.3.FF
DNMA1.4	DNXA1.4.HL	DNXA1.4.AT	DNXA1.4.TG	DNXA1.4.FF
DNMA1.5	DNXA1.5.HL	DNXA1.5.AT	DNXA1.5.TG	DNXA1.5.FF
DNMA1.1.2	DNXA1.1.2.HL	DNXA1.1.2.AT	DNXA1.1.2.TG	DNXA1.1.2.FF
DNMA1.2.1	DNXA1.2.1.HL	DNXA1.2.1.AT	DNXA1.2.1.TG	DNXA1.2.1.FF
DNMA1.3.1	DNXA1.3.1.HL	DNXA1.3.1.AT	DNXA1.3.1.TG	DNXA1.3.1.FF

ACCESORIOS / ACCESSORIES / ACCESSOIRES /



AH40 Separadores (x12 u.) / Separators (x12u.) / *Séparateurs (x12 u.)*



PWA0/ PWA1 Pisapapeles / Paper-weight / *Presse-papiers*

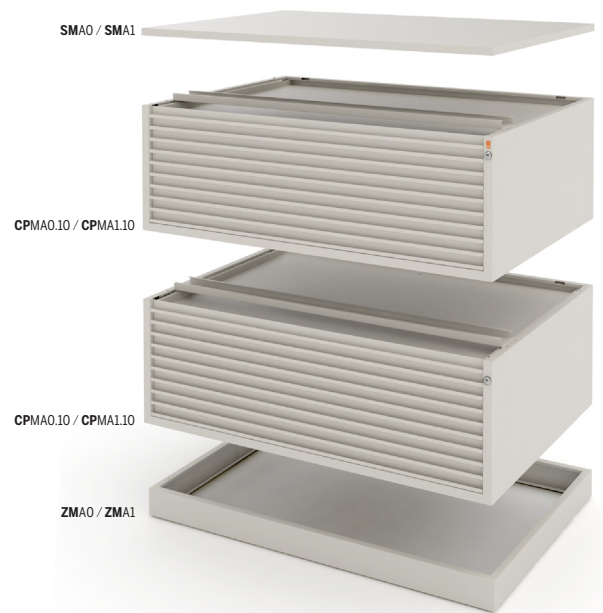

COMPACT /

DESCRIPCIÓN /

- Archivo horizontal de gran capacidad, con mayor número de cajones. Innovador diseño del frontal. En chapa metálica pintado con pintura epoxy.
- Mueble estándar de 20 cajones. Compuesto por dos módulos de 10 cajones, tapa y zócalo.
- Frontal de cajones con tirador en toda la longitud del cajón.
- Guías equipadas con rodamientos a bolas. Deslizamiento suave. 70% de extracción.
- Freno mecánico al final de las guías.
- Cerradura con llave en cada módulo de cajones.
- Carga máxima: 25kg uniformemente repartidos en cada cajón.
- Disponible con 6, 7, 8 y 10 cajones.
- Apilable hasta 3 módulos.
- Disponibles diferentes opciones y accesorios.

DESCRIPTION /

- Large-capacity horizontal archive with greater number of drawers. Innovative design of the front panel. In epoxy-painted metal sheet.
- Standard unit with 20 drawers. Composed of two modules of 10 drawers, top and base.
- Front panel of drawers with full-width handle.
- Guides fitted with ball bearings. Smooth operation. 70% extraction.
- Mechanical brake at guide end stop.
- Lock on each drawer module.
- Maximum load: 25 kg uniformly distributed in each drawer.
- Available with 6, 7, 8 and 10 drawers.
- Stackable up to 3 modules.
- Various options and accessories available.

DESCRIPTION /

- Classeur horizontal à grande capacité, équipé d'un plus grand nombre de tiroirs. Partie avant au design innovant. En tôle métallique et peinture époxy.
- Meuble standard à 20 tiroirs. Constitué de deux modules à 10 tiroirs, dessus et socle.
- Partie avant des tiroirs avec poignée sur toute la longueur du tiroir.
- Coulisses équipées de roulements à billes. Coulissement doux. Extraction à 70%.
- Amortisseur à la fin des coulisses.
- Serrure de sécurité dans chaque module à tiroirs.
- Charge maximale : 25kg répartis uniformément dans chaque tiroir.
- Disponible avec 6, 7, 8, et 10 tiroirs.
- Jusqu'à 3 modules empilables.
- Différentes options et divers accessoires disponibles.

COLOR / COLOUR / COLORIS /

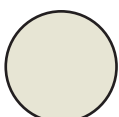

RAL 9002 - Texture
Blanco Grisáceo / Grey White / Blanc Gris

/ Posibilidad de otros colores bajo pedido
/ Possibility of other colors upon request
/ Possibilité d'autres couleurs sur demande

MUEBLE ESTÁNDAR / STANDARD CABINET / MEUBLE STANDARD /

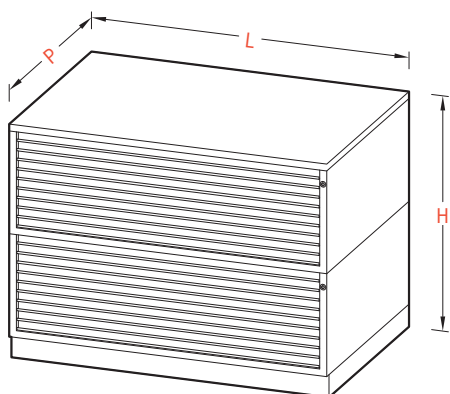

REF.	DESCRIPCIÓN / DESCRIPTION / DESCRIPTION	FORMATO / FORMAT / FORMAT	MEDIDAS / DIMENSIONS / MESURES		
			L	P	H
CPA0.20	Archivo Horizontal de 20 Cajones Filing Cabinet with 20 Drawers <i>Meubles à plans avec 20 Tiroirs</i>	DIN A0 Plus	1410	970	1034
CPA1.20	Archivo Horizontal de 20 Cajones Filing Cabinet with 20 Drawers <i>Meubles à plans avec 20 Tiroirs</i>	DIN A1 Plus	1130	810	1034

MÓDULOS DE AMPLIACIÓN / EXTRA DRAWER UNITS / MODULES D'ÉLARGISSEMENT /

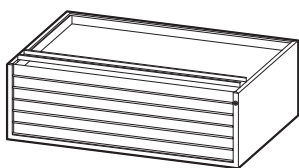

CPMA0.6 / CPMA1.6

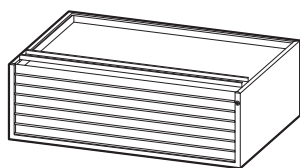

CPMA0.7 / CPMA1.7

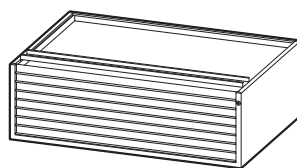

CPMA0.8 / CPMA1.8

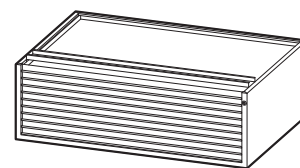

CLMA0.9 / CPMA1.9
/ Módulo de ampliación estándar
/ Standard extra drawer unit
/ Module d'élargissement standard

REF.	NÚMERO DE CAJONES / NUMBER OF DRAWERS / NOMBRE DE TIROIRS	REFERENCIA DE LOS CAJONES / DRAWER REF. / RÉF. DES TIROIRS	FORMATO / FORMAT / FORMAT	MEDIDAS / DIMENSIONS / MESURES		
				L	P	H
CPMA0.6	6 Cajones / 6 Drawers / 6 Tiroirs	6 x CPFRA0.70	DIN A0 Plus	1410	970	453
CPMA0.7	7 Cajones / 7 Drawers / 7 Tiroirs	7 x CPFRA0.60	DIN A0 Plus	1410	970	453
CPMA0.8	8 Cajones / 8 Drawers / 8 Tiroirs	8 x CPFRA0.52	DIN A0 Plus	1410	970	453
CPMA0.10	10 Cajones / 10 Drawers / 10 Tiroirs	10 x CPFRA0.42	DIN A0 Plus	1410	970	453
CPMA1.6	6 Cajones / 6 Drawers / 6 Tiroirs	6 x CPFRA1.70	DIN A1 Plus	1130	810	453
CPMA1.7	7 Cajones / 7 Drawers / 7 Tiroirs	7 x CPFRA1.60	DIN A1 Plus	1130	810	453
CPMA1.8	8 Cajones / 8 Drawers / 8 Tiroirs	8 x CPFRA1.52	DIN A1 Plus	1130	810	453
CPMA1.10	10 Cajones / 10 Drawers / 10 Tiroirs	10 x CPFRA1.42	DIN A1 Plus	1130	810	453

COMPLEMENTOS / COMPLEMENTS / COMPLÉMENTS /



REF.	DESCRIPCIÓN / DESCRIPTION / DESCRIPTION	FORMATO / FORMAT / FORMAT	MEDIDAS / DIMENSIONS / MESURES		
			L	P	H
SMA0	Tapa en chapa de acero / Steel sheet top / Dessus en tôle d'acier	DIN A0 Plus	1410	966	28 mm
ZMA0	Zócalo en chapa de acero / Steel sheet base / Socle en tôle d'acier	DIN A0 Plus	1410	940	100 mm
STMA0	Base con patas / Base with legs / Base avec pieds	DIN A0 Plus	1410	966	420 mm
SMA1	Tapa en chapa de acero / Steel sheet top / Dessus en tôle d'acier	DIN A1 Plus	1130	810	28 mm
ZMA1	Zócalo en chapa de acero / Steel sheet base / Socle en tôle d'acier	DIN A1 Plus	1130	784	100 mm
STMA1	Base con patas / Base with legs / Base avec pieds	DIN A1 Plus	1130	810	420 mm
WHMA01	Base con ruedas / Base with wheels / Base avec roulettes	DIN A0/A1 Plus			110 mm

CAJONES / DRAWERS / TIROIRS /

Los cajones tipo **TISSA COMPACT** se pueden combinar con los del modelo **TISSA DINAMIC**.

The **TISSA COMPACT** type drawers can be combined with those of the **TISSA DINAMIC** model.

Les tiroirs type **TISSA COMPACT** peuvent se combiner avec ceux du modèle **TISSA DINAMIC**.

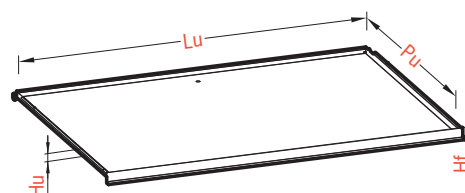

REF.	ALTURA FRONTAL / FRONT HEIGHT / HAUTEUR FAÇADE	CARGA MÁX. / MAX. LOAD / CHARGE MAX.	MEDIDA / SIZE / TAILLE	MEDIDAS ÚTILES / USEFULL DIM. / MES. UTILES		
	Hf			Cm	Lu	Pu
CPFRA0.70	70	25 Kg	DIN A0 Plus	1310	930	50 mm
CPFRA0.60	60	25 Kg	DIN A0 Plus	1310	930	40 mm
CPFRA0.52	52	25 Kg	DIN A0 Plus	1310	930	30 mm
CPFRA0.42	42	25 Kg	DIN A0 Plus	1310	930	25 mm
CPFRA1.70	70	25 Kg	DIN A1 Plus	1030	770	50 mm
CPFRA1.60	60	25 Kg	DIN A1 Plus	1030	770	40 mm
CPFRA1.52	52	25 Kg	DIN A1 Plus	1030	770	30 mm
CPFRA1.42	42	25 Kg	DIN A1 Plus	1030	770	25 mm

OPCIONES EXTRA / EXTRA OPTIONS / OPTIONS SUPPLÉMENTAIRES /



Cajones de 40Kg (uniformemente repartidos) / 40Kg drawers (evenly distributed) /
Tiroirs de 40Kg (uniformément distribué)

REF. CAJONES DE 40 KG /
40 KG DRAWERS /
TIROIRS DE 40 KG

CPMA0.6 CPXA0.6.HL

CPMA0.7 CPXA0.7.HL

CPMA0.8 CPXA0.8.HL

CPMA0.10 CPXA0.10.HL

CPMA1.6 CPXA1.6.HL

CPMA1.7 CPXA1.7.HL

CPMA1.8 CPXA1.8.HL

CPMA1.10 CPXA1.10.HL

ACCESORIOS / ACCESSORIES / ACCESSOIRES /



AH25 Separadores (x12 u.) / Separators (x12u.) / Séparateurs (x12 u.)



PWA0/ PWA1 Pisapapeles / Paper-weight / Presse-papiers



TISSA PREMIUM /

DESCRIPCIÓN /

- Archivo horizontal exclusivo y elegante. En chapa metálica pintado con pintura epoxy.
- Mueble estándar de 10 cajones. Compuesto por dos módulos de 5 cajones, tapa y zócalo.
- Frontal de cajones con tirador de cromado de aluminio y dos portaetiquetas.
- Guías equipadas con rodamientos a bolas. Deslizamiento suave. 70% de extracción.
- Freno mecánico al final de las guías.
- Cerradura con llave en cada módulo de cajones.
- Carga máxima: 25kg uniformemente repartidos en cada cajón.
- Apilable hasta 5 módulos.
- Disponibles diferentes opciones y accesorios.

DESCRIPTION /

- Exclusive, elegant horizontal archive. In epoxy-painted metal sheet.
- Standard unit with 10 drawers. Composed of two modules of 5 drawers, top and base.
- Front panel of drawers with chrome-plated aluminium handle and two label holders.
- Guides fitted with ball bearings. Smooth operation. 70% extraction.
- Mechanical brake at guide end stop.
- Lock on each drawer module.
- Maximum load: 25 kg uniformly distributed in each drawer.
- Stackable up to 5 modules.
- Various options and accessories available.

DESCRIPTION /

- Classeur horizontal exclusif et élégant. En tôle métallique et peinture époxy.
- Meuble standard à 10 tiroirs. Constitué de deux modules à 5 tiroirs, dessus et socle.
- Partie avant des tiroirs avec poignée en aluminium chromé et deux porte-étiquettes.
- Coulisses équipées de roulements à billes. Coulissement doux. Extraction à 70%.
- Amortisseur à la fin des coulisses.
- Serrure de sécurité dans chaque module à tiroirs.
- Charge maximale : 25kg répartis uniformément dans chaque tiroir.
- Jusqu'à 5 modules empilables
- Différentes options et divers accessoires disponibles.

COLOR / COLOUR / COLORIS /



RAL 9005 - Texture
Negro Intenso / Intense Black / Noir Intense

MUEBLE ESTÁNDAR / STANDARD CABINET / MEUBLE STANDARD /

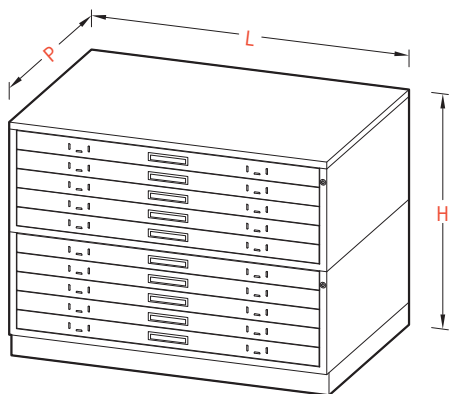

REF.	DESCRIPCIÓN / DESCRIPTION / DESCRIPTION	FORMATO / FORMAT / FORMAT	MEDIDAS / DIMENSIONS / MESURES		
			L	P	H
PMA0.10	Archivo Horizontal de 10 Cajones Filing Cabinet with 10 Drawers <i>Meubles à plans avec 10 Tiroirs</i>	DIN A0 Plus	1410	970	1034
PMA1.10	Archivo Horizontal de 10 Cajones Filing Cabinet with 10 Drawers <i>Meubles à plans avec 10 Tiroirs</i>	DIN A1 Plus	1130	810	1034

MÓDULOS DE AMPLIACIÓN / EXTRA DRAWER UNITS / MODULES D'ÉLARGISSEMENT /

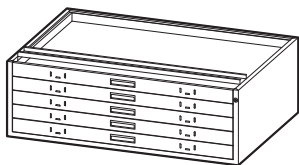

PMMA0.5 / PMMA1.5
/ Módulo de ampliación estándar
/ Standard extra drawer unit
/ Module d'élargissement standard

REF.	NÚMERO DE CAJONES / NUMBER OF DRAWERS / NOMBRE DE TIROIRS	REFERENCIA DE LOS CAJONES / DRAWER REF. / RÉF. DES TIROIRS	FORMATO / FORMAT / FORMAT	MEDIDAS / DIMENSIONS / MESURES		
				L	P	H
PMMA0.5	5 Cajones / 5 Drawers / 5 Tiroirs	5 x PMFRA0.84	DIN A0 Plus	1410	970	453
PMMA1.5	5 Cajones / 5 Drawers / 5 Tiroirs	5 x PMFRA1.84	DIN A1 Plus	1130	810	453

COMPLEMENTOS / COMPLEMENTS / COMPLÉMENTS /



REF.	DESCRIPCIÓN / DESCRIPTION / DESCRIPTION	FORMATO / FORMAT / FORMAT	MEDIDAS / DIMENSIONS / MESURES		
			L	P	H
SMPA0	Tapa en chapa de acero / Steel sheet top / Dessus en tôle d'acier	DIN A0 Plus	1410	966	28 mm
ZMPA0	Zócalo en chapa de acero / Steel sheet base / Socle en tôle d'acier	DIN A0 Plus	1410	940	100 mm
STMPA0	Base con patas / Base with legs / Base avec pieds	DIN A0 Plus	1410	966	420 mm
SMPA1	Tapa en chapa de acero / Steel sheet top / Dessus en tôle d'acier	DIN A1 Plus	1130	810	28 mm
ZMPA1	Zócalo en chapa de acero / Steel sheet base / Socle en tôle d'acier	DIN A1 Plus	1130	784	100 mm
STMPA1	Base con patas / Base with legs / Base avec pieds	DIN A1 Plus	1130	810	420 mm
WHMA01	Base con ruedas / Base with wheels / Base avec roulettes	DIN A0/A1 Plus			110 mm

CAJONES / DRAWERS / TIROIRS /

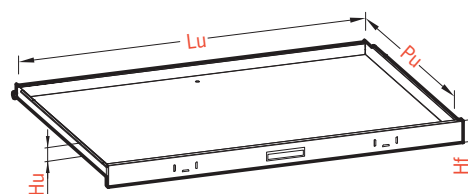

REF.	ALTURA FRONTAL / FRONT HEIGHT / HAUTEUR FAÇADE	CARGA MÁX. / MAX. LOAD / CHARGE MAX.	MEDIDA / SIZE / TAILLE	MEDIDAS ÚTILES / USEFULL DIM. / MES. UTILES		
	Hf			Cm	Lu	Pu
PMFRA0.41	84	25 Kg	DIN A0 Plus	1310	920	55 mm
PMFRA1.41	84	25 Kg	DIN A1 Plus	1030	760	55 mm

OPCIONES EXTRA / EXTRA OPTIONS / OPTIONS SUPPLÉMENTAIRES /



Cajones de 40Kg (uniformemente repartidos) / 40Kg drawers (evenly distributed) /
Tiroirs de 40Kg (uniformément distribué)

REF. CAJONES DE 40 KG /
40 KG DRAWERS /
TIROIRS DE 40 KG

PMMA0.5 CLXA0.5.HL

PMMA1.5 CLXA1.5.HL

ACCESORIOS / ACCESSORIES / ACCESSOIRES /



AH40 Separadores (x12 u.) / Separators (x12u.) / *Séparateurs (x12 u.)*

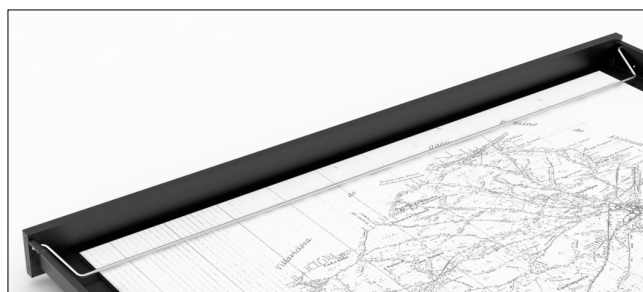

PWA0/ PWA1 Pisapapeles / Paper-weight / *Presse-papiers*